





















## Thru-beam Mode (Standard shape)

C: M12 SERIES

Sensing Mode	Housing Material	Connection	Supply Voltage	Output Mode	Part Number
<p>Light Source: Infrared 880nm</p>  <p>Thru-beam Mode Sensing distance: 5.2 m</p>	Plastic Housing	2m Cable 	10-30V DC	Emitter	M12P-T5200D-EX9C3L2
				NPN L.O./D.O.	M12P-T5200N-CX9C4U2
				PNP L.O./D.O.	M12P-T5200P-CX9C4U2
			Quick Disconnect (Pico-style) 	Emitter	M12P-T5200D-EX9Q4LP
			NPN L.O./D.O.	M12P-T5200N-CX9Q4UP	
			PNP L.O./D.O.	M12P-T5200P-CX9Q4UP	
			Quick Disconnect (Euro-style) 	Emitter	M12P-T5200D-EX9Q4LE
			NPN L.O./D.O.	M12P-T5200N-CX9Q4UE	
			PNP L.O./D.O.	M12P-T5200P-CX9Q4UE	
			6" Pig tail (Euro-style) 	Emitter	M12P-T5200D-EX9P3LE
			NPN L.O./D.O.	M12P-T5200N-CX9P4UE	
			PNP L.O./D.O.	M12P-T5200P-CX9P4UE	
	Nickel-plated Brass Housing		Cable 	10-30V DC	Emitter
			NPN L.O./D.O.		M12B-T5200N-CX9C4U2
			PNP L.O./D.O.		M12B-T5200P-CX9C4U2
			Quick Disconnect (Pico-style) 	Emitter	M12B-T5200D-EX9Q4LP
			NPN L.O./D.O.	M12B-T5200N-CX9Q4UP	
			PNP L.O./D.O.	M12B-T5200P-CX9Q4UP	
			Quick Disconnect (Euro-style) 	Emitter	M12B-T5200D-EX9Q4LE
			NPN L.O./D.O.	M12B-T5200N-CX9Q4UE	
PNP L.O./D.O.			M12B-T5200P-CX9Q4UE		
6" Pig tail (Euro-style) 			Emitter	M12B-T5200D-EX9P4LE	
		NPN L.O./D.O.	M12B-T5200N-CX9P4UE		
		PNP L.O./D.O.	M12B-T5200P-CX9P4UE		

## Thru-beam Mode (Y Shape)

Sensing Mode	Housing Material	Connection	Supply Voltage	Output Mode	Part Number
<p>Light Source: Infrared 880nm</p>  <p>5.2 m</p> <p>Thru-beam Mode Sensing distance: 5.2 m</p>	Plastic Housing	2m Cable  CE	10-30V DC	Emitter	<u>M12P-T5200D-EY9C3L2</u>
				NPN L.O./D.O.	M12P-T5200N-CY9C4U2
				PNP L.O./D.O.	M12P-T5200P-CY9C4U2
		Quick Disconnect (Pico-style)  CE	10-30V DC	Emitter	M12P-T5200D-EY9Q4LP
				NPN L.O./D.O.	M12P-T5200N-CY9Q4UP
				PNP L.O./D.O.	M12P-T5200P-CY9Q4UP
		6" Pig tail (Euro-style)  CE	10-30V DC	Emitter	M12P-T5200D-EY9P4LE
				NPN L.O./D.O.	M12P-T5200N-CY9P4UE
				PNP L.O./D.O.	M12P-T5200P-CY9P4UE
	Nickel-plated Brass Housing	2m Cable  CE	10-30V DC	Emitter	<u>M12B-T5200D-EY9C3L2</u>
				NPN L.O./D.O.	M12B-T5200N-CY9C4U2
				PNP L.O./D.O.	M12B-T5200P-CY9C4U2
Quick Disconnect (Pico-style)  CE		10-30V DC	Emitter	M12B-T5200D-EY9Q4LP	
			NPN L.O./D.O.	M12B-T5200N-CY9Q4UP	
			PNP L.O./D.O.	M12B-T5200P-CY9Q4UP	
6" Pig tail (Euro-style)  CE		10-30V DC	Emitter	M12B-T5200D-EY9P4LE	
			NPN L.O./D.O.	M12B-T5200N-CY9P4UE	
			PNP L.O./D.O.	M12B-T5200P-CY9P4UE	











Note:

Coming Soon : Part numbers with underline

In Preparation: Part numbers with a line through the middle









## Thru-beam Mode (Z shape)

C: M12 SERIES

Sensing Mode	Housing Material	Connection	Supply Voltage	Output Mode	Part Number
 <p>Light Source: Infrared 880nm</p> <p>Thru-beam Mode Sensing distance: 5.2 m</p>	Plastic Housing	2m Cable 	10-30V DC	Emitter	<u>M12P-T5200D-EZ9C3L2</u>
				NPN L.O./D.O.	<u>M12P-T5200N-CZ9C4U2</u>
				PNP L.O./D.O.	<u>M12P-T5200P-CZ9C4U2</u>
		Quick Disconnect (Pico-style) 	10-30V DC	Emitter	<u>M12P-T5200D-EZ9Q4LP</u>
				NPN L.O./D.O.	<u>M12P-T5200N-CZ9Q4UP</u>
				PNP L.O./D.O.	<u>M12P-T5200P-CZ9Q4UP</u>
		Quick Disconnect (Euro-style) 	10-30V DC	Emitter	<u>M12P-T5200D-EZ9Q4LE</u>
				NPN L.O./D.O.	<u>M12P-T5200N-CZ9Q4UE</u>
				PNP L.O./D.O.	<u>M12P-T5200P-CZ9Q4UE</u>
		6" Pig tail (Euro-style) 	10-30V DC	Emitter	<u>M12P-T5200D-EZ9P4LE</u>
				NPN L.O./D.O.	<u>M12P-T5200N-CZ9P4UE</u>
				PNP L.O./D.O.	<u>M12P-T5200P-CZ9P4UE</u>
 <p>Thru-beam Mode Sensing distance: 5.2 m</p>	Nickel-plated Brass Housing	2m Cable 	10-30V DC	Emitter	<u>M12B-T5200D-EZ9C3L2</u>
				NPN L.O./D.O.	<u>M12B-T5200N-CZ9C4U2</u>
				PNP L.O./D.O.	<u>M12B-T5200P-CZ9C4U2</u>
		Quick Disconnect (Pico-style) 	10-30V DC	Emitter	<u>M12B-T5200D-EZ9Q4LP</u>
				NPN L.O./D.O.	<u>M12B-T5200N-CZ9Q4UP</u>
				PNP L.O./D.O.	<u>M12B-T5200P-CZ9Q4UP</u>
		Quick Disconnect (Euro-style) 	10-30V DC	Emitter	<u>M12B-T5200D-EZ9Q4LE</u>
				NPN L.O./D.O.	<u>M12B-T5200N-CZ9Q4UE</u>
				PNP L.O./D.O.	<u>M12B-T5200P-CZ9Q4UE</u>
		6" Pig tail (Euro-style) 	10-30V DC	Emitter	<u>M12B-T5200D-EZ9P4LE</u>
				NPN L.O./D.O.	<u>M12B-T5200N-CZ9P4UE</u>
				PNP L.O./D.O.	<u>M12B-T5200P-CZ9P4UE</u>

Note:  
 Coming Soon : Part numbers with underline  
 In Preparation: Part numbers with a line through the middle

## Diffuse Mode (Standard shape)

Sensing Mode	Housing Material	Connection	Supply Voltage	Output Mode	Part Number
Light Source: Infrared 880nm  200mm Diffuse Mode Sensing Distance: 200 mm	Plastic Housing	2m Cable  CE	10-30V DC	NPN L.O./D.O.	M12P-D0200N-CX9C4U2
				PNP L.O./D.O.	M12P-D0200P-CX9C4U2
				—	—
		Quick Disconnect (Pico-style)  CE	10-30V DC	NPN L.O./D.O.	M12P-D0200N-CX9Q4UP
				PNP L.O./D.O.	M12P-D0200P-CX9Q4UP
				—	—
		Quick Disconnect (Euro-style)  CE	10-30V DC	NPN L.O./D.O.	M12P-D0200N-CX9Q4UE
				PNP L.O./D.O.	M12P-D0200P-CX9Q4UE
				—	—
		6" Pig tail (Euro-style)  CE	10-30V DC	NPN L.O./D.O.	M12P-D0200N-CX9P4UE
				PNP L.O./D.O.	M12P-D0200P-CX9P4UE
				—	—
	Nickel-plated Brass Housing	2m Cable  CE	10-30V DC	NPN L.O./D.O.	M12B-D0200N-CX9C4U2
				PNP L.O./D.O.	M12B-D0200P-CX9C4U2
				—	—
		Quick Disconnect (Pico-style)  CE	10-30V DC	NPN L.O./D.O.	M12B-D0200N-CX9Q4UP
PNP L.O./D.O.				M12B-D0200P-CX9Q4UP	
—				—	
Quick Disconnect (Euro-style)  CE		10-30V DC	NPN L.O./D.O.	M12B-D0200N-CX9Q4UE	
			PNP L.O./D.O.	M12B-D0200P-CX9Q4UE	
			—	—	
6" Pig tail (Euro-style)  CE		10-30V DC	NPN L.O./D.O.	M12B-D0200N-CX9P4UE	
			PNP L.O./D.O.	M12B-D0200P-CX9P4UE	
			—	—	







Note:

Coming Soon : Part numbers with underline

In Preparation: Part numbers with a line through the middle

## Diffuse Mode (Y Shape)

C: M12 SERIES









Sensing Mode	Housing Material	Connection	Supply Voltage	Output Mode	Part Number
Light Source: Infrared 880nm  200mm Diffuse Mode Sensing Distance: 200 mm	Plastic Housing	2m Cable  CE	10-30V DC	NPN L.O./D.O.	<u>M12P-D0200N-CY9C4U2</u>
				PNP L.O./D.O.	<u>M12P-D0200P-CY9C4U2</u>
				—	—
		Quick Disconnect (Pico-style)  CE	10-30V DC	NPN L.O./D.O.	<u>M12P-D0200N-CY9Q4UP</u>
				PNP L.O./D.O.	<u>M12P-D0200P-CY9Q4UP</u>
				—	—
	6" Pig tail (Euro-style)  CE	10-30V DC	NPN L.O./D.O.	<u>M12P-D0200N-CY9P4UE</u>	
			PNP L.O./D.O.	<u>M12P-D0200P-CY9P4UE</u>	
			—	—	
	Nickel-plated Brass Housing	2m Cable  CE	10-30V DC	NPN L.O./D.O.	<u>M12B-D0200N-CY9C4U2</u>
				PNP L.O./D.O.	<u>M12B-D0200P-CY9C4U2</u>
				—	—
Quick Disconnect (Pico-style)  CE		10-30V DC	NPN L.O./D.O.	<u>M12B-D0200N-CY9Q4UP</u>	
			PNP L.O./D.O.	<u>M12B-D0200P-CY9Q4UP</u>	
			—	—	
6" Pig tail (Euro-style)  CE	10-30V DC	NPN L.O./D.O.	<u>M12B-D0200N-CY9P4UE</u>		
		PNP L.O./D.O.	<u>M12B-D0200P-CY9P4UE</u>		
		—	—		

Note:

Coming Soon : Part numbers with underline

In Preparation: Part numbers with a line through the middle









## Diffuse Mode (Z shape)

Sensing Mode	Housing Material	Connection	Supply Voltage	Output Mode	Part Number
<p>Light Source: Infrared 880nm</p> <p>200mm</p> <p>Diffuse Mode Sensing Distance: 200 mm</p> 	Plastic Housing	2m Cable 	10-30V DC	NPN L.O./D.O.	<u>M12P-D0200N-CZ9C4U2</u>
				PNP L.O./D.O.	<u>M12P-D0200P-CZ9C4U2</u>
				—	—
		Quick Disconnect (Pico-style) 	10-30V DC	NPN L.O./D.O.	<u>M12P-D0200N-CZ9Q4UP</u>
				PNP L.O./D.O.	<u>M12P-D0200P-CZ9Q4UP</u>
				—	—
		Quick Disconnect (Euro-style) 	10-30V DC	NPN L.O./D.O.	<u>M12P-D0200N-CZ9Q4UE</u>
				PNP L.O./D.O.	<u>M12P-D0200P-CZ9Q4UE</u>
				—	—
		6" Pig tail (Euro-style) 	10-30V DC	NPN L.O./D.O.	<u>M12P-D0200N-CZ9P4UE</u>
				PNP L.O./D.O.	<u>M12P-D0200P-CZ9P4UE</u>
				—	—
	Nickel-plated Brass Housing	2m Cable 	10-30V DC	NPN L.O./D.O.	<u>M12B-D0200N-CZ9C4U2</u>
				PNP L.O./D.O.	<u>M12B-D0200P-CZ9C4U2</u>
				—	—
		Quick Disconnect (Pico-style) 	10-30V DC	NPN L.O./D.O.	<u>M12B-D0200N-CZ9Q4UP</u>
PNP L.O./D.O.				<u>M12B-D0200P-CZ9Q4UP</u>	
—				—	
Quick Disconnect (Euro-style) 		10-30V DC	NPN L.O./D.O.	<u>M12B-D0200N-CZ9Q4UE</u>	
			PNP L.O./D.O.	<u>M12B-D0200P-CZ9Q4UE</u>	
			—	—	
6" Pig tail (Euro-style) 		10-30V DC	NPN L.O./D.O.	<u>M12B-D0200N-CZ9P4UE</u>	
			PNP L.O./D.O.	<u>M12B-D0200P-CZ9P4UE</u>	
			—	—	

Note:  
 Coming Soon : Part numbers with underline  
 In Preparation: Part numbers with a line through the middle

## Retroreflective Mode (Standard shape)

C: M12 SERIES







Sensing Mode	Housing Material	Connection	Supply Voltage	Output Mode	Part Number	
<p>Light Source: Infrared 880nm</p>  <p>2 m</p> <p>Retro-reflective mode Sensing distance: 2 m (Note)</p>	Plastic Housing	2m Cable	10-30V DC	NPN L.O./D.O.	M12P-L2000N-CX9C4U2	
				PNP L.O./D.O.	M12P-L2000P-CX9C4U2	
				—	—	
		Quick Disconnect (Pico-style)	10-30V DC		NPN L.O./D.O.	M12P-L2000N-CX9Q4UP
					PNP L.O./D.O.	<u>M12P-L2000P-CX9Q4UP</u>
		—		—		
		Quick Disconnect (Euro-style)	10-30V DC		NPN L.O./D.O.	M12P-L2000N-CX9Q4UE
					PNP L.O./D.O.	M12P-L2000P-CX9Q4UE
	—	—				
	6" Pig tail (Euro-style)	10-30V DC		NPN L.O./D.O.	M12P-L2000N-CX9P4UE	
				PNP L.O./D.O.	M12P-L2000P-CX9P4UE	
			—	—		
			—	—		
	Nickel-plated Brass Housing	2m Cable		10-30V DC	NPN L.O./D.O.	M12B-L2000N-CX9C4U2
					PNP L.O./D.O.	M12B-L2000P-CX9C4U2
					—	—
Quick Disconnect (Pico-style)		10-30V DC		NPN L.O./D.O.	M12B-L2000N-CX9Q4UP	
				PNP L.O./D.O.	M12B-L2000P-CX9Q4UP	
—			—			
Quick Disconnect (Euro-style)		10-30V DC		NPN L.O./D.O.	M12B-L2000N-CX9Q4UE	
				PNP L.O./D.O.	M12B-L2000P-CX9Q4UE	
—	—					
6" Pig tail (Euro-style)	10-30V DC		NPN L.O./D.O.	M12B-L2000N-CX9P4UE		
			PNP L.O./D.O.	M12B-L2000P-CX9P4UE		
		—	—			

**Note:**

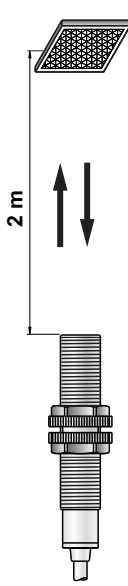
Used with RE-6152 (supplied with sensor) reflector.

In Preparation: Part numbers with a line through the middle

## Retroreflective Mode (Y Shape)

Sensing Mode	Housing Material	Connection	Supply Voltage	Output Mode	Part Number	
<p>Light Source: Infrared 880nm</p>  <p>2m</p> <p>Retro-reflective mode Sensing distance: 2m (Note)</p>	Plastic Housing	2m Cable	10-30V DC	NPN L.O./D.O.	M12P-L2000N-CY9C4U2	
				PNP L.O./D.O.	M12P-L2000P-CY9C4U2	
		CE		—	—	
		Quick Disconnect (Pico-style)	10-30V DC	NPN L.O./D.O.	M12P-L2000N-CY9Q4UP	
				PNP L.O./D.O.	M12P-L2000P-CY9Q4UP	
		CE		—	—	
	6" Pig tail (Euro-style)	10-30V DC	NPN L.O./D.O.	M12P-L2000N-CY9P4UE		
			PNP L.O./D.O.	M12P-L2000P-CY9P4UE		
	CE		—	—		
	Nickel-plated Brass Housing	2m Cable		10-30V DC	NPN L.O./D.O.	M12B-L2000N-CY9C4U2
					PNP L.O./D.O.	M12B-L2000P-CY9C4U2
					CE	—
Quick Disconnect (Pico-style)			10-30V DC	NPN L.O./D.O.	M12B-L2000N-CY9Q4UP	
				PNP L.O./D.O.	M12B-L2000P-CY9Q4UP	
				CE	—	—
6" Pig tail (Euro-style)		10-30V DC	NPN L.O./D.O.	M12B-L2000N-CY9P4UE		
			PNP L.O./D.O.	M12B-L2000P-CY9P4UE		
			CE	—	—	

**Note:**







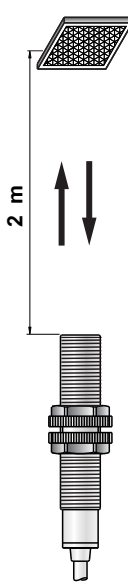

Used with RE-6152 (supplied with sensor) reflector.

In Preparation: Part numbers with a line through the middle



## Retroreflective Mode (Z shape)

C: M12 SERIES

Sensing Mode	Housing Material	Connection	Supply Voltage	Output Mode	Part Number	
<p>Light Source: Infrared 880nm</p>  <p>2 m</p> <p>Retro-reflective mode Sensing distance: 2 m (Note)</p>	Plastic Housing	2m Cable 	10-30V DC	NPN L.O./D.O.	<u>M12P-L2000N-CZ9C4U2</u>	
				10-30V DC	PNP L.O./D.O.	<u>M12P-L2000P-CZ9C4U2</u>
					————	————
			10-30V DC	NPN L.O./D.O.	<u>M12P-L2000N-CZ9Q4UE</u>	
				PNP L.O./D.O.	<u>M12P-L2000P-CZ9Q4UE</u>	
			10-30V DC	NPN L.O./D.O.	<u>M12P-L2000N-CZ9P4UE</u>	
				PNP L.O./D.O.	<u>M12P-L2000P-CZ9P4UE</u>	
		Nickel-plated Brass Housing		10-30V DC	NPN L.O./D.O.	<u>M12B-L2000N-CZ9C4U2</u>
					PNP L.O./D.O.	<u>M12B-L2000P-CZ9C4U2</u>
					————	————
				10-30V DC	NPN L.O./D.O.	<u>M12B-L2000N-CZ9Q4UP</u>
		PNP L.O./D.O.			<u>M12B-L2000P-CZ9Q4UP</u>	
		10-30V DC	NPN L.O./D.O.	<u>M12B-L2000N-CZ9Q4UE</u>		
			PNP L.O./D.O.	<u>M12B-L2000P-CZ9Q4UE</u>		
		10-30V DC	NPN L.O./D.O.	<u>M12B-L2000N-CZ9P4UE</u>		
			PNP L.O./D.O.	<u>M12B-L2000P-CZ9P4UE</u>		







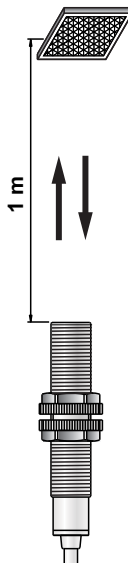

**Note:**

Used with RE-6152 (supplied with sensor) reflector.

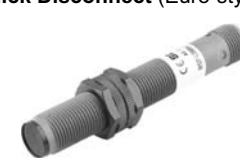
Coming Soon : Part numbers with underline

In Preparation: Part numbers with a line through the middle







## Retroreflective Mode with Polarizing Filter (Standard shape)

Sensing Mode	Housing Material	Connection	Supply Voltage	Output Mode	Part Number
<p><b>Retro-reflective Mode</b> (with polarizing filter) Sensing distance: 1 m (Note)</p> 	Plastic Housing	2m Cable	10-30V DC	NPN L.O./D.O.	M12P-L1000N-CX6C4U2-PF
				PNP L.O./D.O.	M12P-L1000P-CX6C4U2-PF
				—	—
		Quick Disconnect (Pico-style)	10-30V DC	NPN L.O./D.O.	M12P-L1000N-CX6Q4UP-PF
				PNP L.O./D.O.	M12P-L1000P-CX6Q4UP-PF
				—	—
		Quick Disconnect (Euro-style)	10-30V DC	NPN L.O./D.O.	M12P-L1000N-CX6Q4UE-PF
				PNP L.O./D.O.	M12P-L1000P-CX6Q4UE-PF
				—	—
		6" Pig tail (Euro-style)	10-30V DC	NPN L.O./D.O.	M12P-L1000N-CX6P4UE-PF
				PNP L.O./D.O.	M12P-L1000P-CX6P4UE-PF
				—	—
	Nickel-plated Brass Housing	2m Cable	10-30V DC	NPN L.O./D.O.	M12B-L1000N-CX6C4U2-PF
				PNP L.O./D.O.	M12B-L1000P-CX6C4U2-PF
				—	—
		Quick Disconnect (Pico-style)	10-30V DC	NPN L.O./D.O.	M12B-L1000N-CX6Q4UP-PF
		PNP L.O./D.O.		M12B-L1000P-CX6Q4UP-PF	
		—		—	
Quick Disconnect (Euro-style)		10-30V DC	NPN L.O./D.O.	M12B-L1000N-CX6Q4UE-PF	
			PNP L.O./D.O.	M12B-L1000P-CX6Q4UE-PF	
	—		—		
6" Pig tail (Euro-style)	10-30V DC	NPN L.O./D.O.	M12B-L1000N-CX6P4UE-PF		
		PNP L.O./D.O.	M12B-L1000P-CX6P4UE-PF		
		—	—		

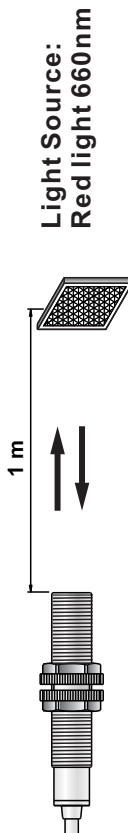
Note: Used with RE-6152 (supplied with sensor) reflector.

## Retroreflective Mode with Polarizing Filter (Y shape)

C: M12 SERIES











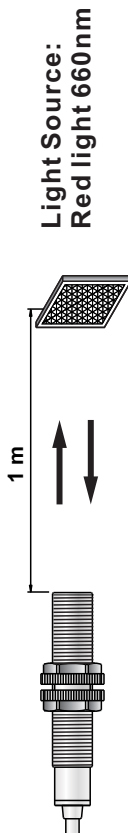





Sensing Mode	Housing Material	Connection	Supply Voltage	Output Mode	Part Number		
<p><b>Retro-reflective mode</b> (with polarizing filter) Sensing distance: 1 m (Note)</p>  <p>Light Source: Red light 660nm</p>	Plastic Housing	2m Cable	10-30V DC	NPN L.O./D.O.	M12P-L1000N-CY6C4U2-PF		
				CE	PNP L.O./D.O.	M12P-L1000P-CY6C4U2-PF	
				—	—		
		Quick Disconnect (Pico-style)	10-30V DC	NPN L.O./D.O.	M12P-L1000N-CY6Q4UP-PF		
				CE	PNP L.O./D.O.	M12P-L1000P-CY6Q4UP-PF	
				—	—		
	6" Pig tail (Euro-style)	10-30V DC	NPN L.O./D.O.	M12P-L1000N-CY6P4UE-PF			
			CE	PNP L.O./D.O.	M12P-L1000P-CY6P4UE-PF		
			—	—			
	Nickel-plated Brass Housing	2m Cable		10-30V DC	NPN L.O./D.O.	M12B-L1000N-CY6C4U2-PF	
					CE	PNP L.O./D.O.	M12B-L1000P-CY6C4U2-PF
					—	—	
Quick Disconnect (Pico-style)		10-30V DC		NPN L.O./D.O.	M12B-L1000N-CY6Q4UP-PF		
				CE	PNP L.O./D.O.	M12B-L1000P-CY6Q4UP-PF	
				—	—		
6" Pig tail (Euro-style)	10-30V DC		NPN L.O./D.O.	M12B-L1000N-CY6P4UE-PF			
			CE	PNP L.O./D.O.	M12B-L1000P-CY6P4UE-PF		
			—	—			

**Note:**

Used with RE-6152 (supplied with sensor) reflector.

In Preparation: Part numbers with a line through the middle

## Retroreflective Mode with Polarizing Filter (Z shape)

Sensing Mode	Housing Material	Connection	Supply Voltage	Output Mode	Part Number	
<p>Light Source: Red light 660nm</p>  <p>1 m</p> <p>Retro-reflective mode (with polarizing filter) Sensing distance: 1m (Note)</p>	Plastic Housing	2m Cable	10-30V DC	NPN L.O./D.O.	<u>M12P-L1000N-CZ6C4U2-PF</u>	
		 		PNP L.O./D.O.	<u>M12P-L1000P-CZ6C4U2-PF</u>	
				—	—	
		Quick Disconnect (Pico-style)	10-30V DC	 	NPN L.O./D.O.	<u>M12P-L1000N-CZ6Q4UP-PF</u>
					PNP L.O./D.O.	<u>M12P-L1000P-CZ6Q4UP-PF</u>
					—	—
		Quick Disconnect (Euro-style)	10-30V DC	 	NPN L.O./D.O.	<u>M12P-L1000N-CZ6Q4UE-PF</u>
					PNP L.O./D.O.	<u>M12P-L1000P-CZ6Q4UE-PF</u>
					—	—
		6" Pig tail (Euro-style)	10-30V DC	 	NPN L.O./D.O.	<u>M12P-L1000N-CZ6P4UE-PF</u>
					PNP L.O./D.O.	<u>M12P-L1000P-CZ6P4UE-PF</u>
					—	—
	Nickel-plated Brass Housing	2m Cable	 	10-30V DC	NPN L.O./D.O.	<u>M12B-L1000N-CZ6C4U2-PF</u>
					PNP L.O./D.O.	<u>M12B-L1000P-CZ6C4U2-PF</u>
					—	—
		Quick Disconnect (Pico-style)	10-30V DC	 	NPN L.O./D.O.	<u>M12B-L1000N-CZ6Q4UP-PF</u>
PNP L.O./D.O.					<u>M12B-L1000P-CZ6Q4UP-PF</u>	
—					—	
Quick Disconnect (Euro-style)		10-30V DC	 	NPN L.O./D.O.	<u>M12B-L1000N-CZ6Q4UE-PF</u>	
				PNP L.O./D.O.	<u>M12B-L1000P-CZ6Q4UE-PF</u>	
				—	—	
6" Pig tail (Euro-style)		10-30V DC	 	NPN L.O./D.O.	<u>M12B-L1000N-CZ6P4UE-PF</u>	
				PNP L.O./D.O.	<u>M12B-L1000P-CZ6P4UE-PF</u>	
				—	—	

Note:  
 Coming Soon : Part numbers with underline  
 In Preparation: Part numbers with a line through the middle

## Specifications

Item	Type Model No.	Thru-beam	Retroreflective		Diffuse reflective
				With polarizing filters	
		M12x-T5200x-xxxxxx	M12x-L2000x-xxxxxx	M12x-L1000x-xxxxxx-PF	M12x-D0200x-xxxxxx
Sensing range		5.2m	2.0m (Note)	1m (Note)	200mm
Sensing object		Opaque object of 8mm or more	3-way mirror	3-way mirror	White paper
Hysteresis					20% or less of operation distance
Supply Voltage		10 to 30V DC Ripple P-P 10% or less			
Current consumption		30mA or less			
Output		<NPN> output type NPN open-collector transistor <ul style="list-style-type: none"> <li>• Applied voltage: 30V DC or less</li> <li>• Maximum sink current: 150mA</li> <li>• Voltage drop: 2.5V or less</li> </ul>		<PNP> output type PNP open-collector transistor <ul style="list-style-type: none"> <li>• Applied voltage: 30V DC or less</li> <li>• Maximum source current: 150mA</li> <li>• Voltage drop: 2.5V or less</li> </ul>	
Output operation		Light/ dark changeover by the A. load or B. Load			
Short-circuit protection		Yes			
Reverse polarity protection		Yes			
Overload current protection		Yes			
Response time		1ms			
Operation indicator		Red LED (light up when the output is activated)			
Pollution degree		3(Industrial environment)			
Protection		IP67(IEC)			
Ambient temperature		-25 to 70°C			
Ambient humidity		35 to 85% RH, Storage: 35 to 85% RH			
EMC		IEC 60947-5-2, Parts 7.2.6.1. 2. 3 or RFI>3V/m(in 30-1000MHZ), EFT>1KV, ESD>4KV(contact)			
Voltage Withstand Ability		IEC 60947-5-2, Part 8.3.3.4 or 1500VAC for one min, between all supply terminals connected together and enclosure			
Insulation Resistance		>20M <sup>Ω</sup> , with 1500V AC megger between all supply terminals connected together and enclosure			
Vibration Resistance		IEC 60947-5-2, Part 7.4.2 or 10-55Hz, 1.0mm amplitude in x, y and z directions for 30 min			
Shock Resistance		IEC 60947-5-2, Part 7.4.1 or 30g, 11ms in x, y and z directions for six time each			
Emitting element		Infrared LED (modulated)	Infrared LED (modulated)	Red LED (modulated)	Infrared LED (modulated)
Material		Plastic Housing: PBT; Metal Housing: Nickel-plated Brass			
Cable		Cable 2m long with 4 conductors (Emitter of thru-beam mode with 3 conductors)			
Pigtail type		See Pigtail Series or our Cables & Connectors catalogue.			

Note: Used with RE-6152 (supplied with sensor) reflector.

## Connection & Sensing Characteristics

### NPN output type

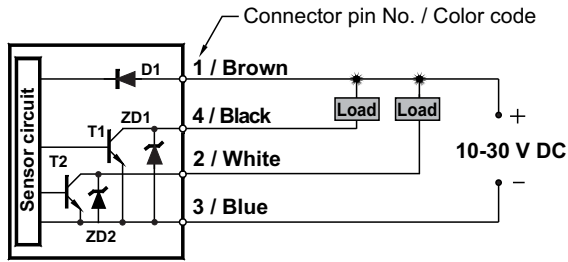

#### Connector pin position

##### Euro-style



- 1. Brown (+)
- 2. White (Output B)
- 3. Blue (-)
- 4. Black (Output A)

##### Pico-Style



- 1. Brown (+)
- 2. White (Output B)
- 3. Blue (-)
- 4. Black (Output A)

Symbol D1: Reverse polarity protection diode  
 ZD1, ZD2: Surge absorption zener diode  
 T1, T2: NPN output transistor

### PNP output type

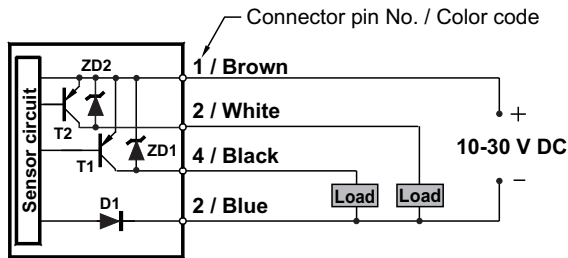

#### Connector pin position

##### Euro-style



- 1. Brown (+)
- 2. White (Output B)
- 3. Blue (-)
- 4. Black (Output A)

##### Pico-Style



- 1. Brown (+)
- 2. White (Output B)
- 3. Blue (-)
- 4. Black (Output A)

Symbol D1: Reverse polarity protection diode  
 ZD1: Surge absorption zener diode  
 T1: PNP output transistor

### Emitter of Thru-beam Mode

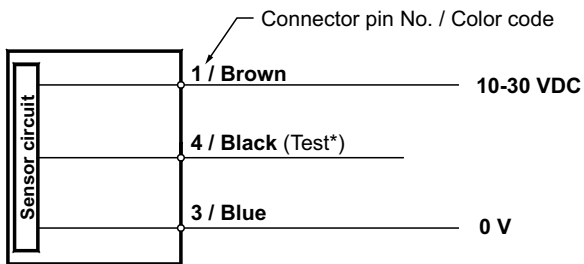

#### Connector pin position

##### Euro-style



- 1. Brown (+)
- 2. Not used
- 3. Blue (-)
- 4. Black (Test in)

##### Pico-Style



- 1. Brown (+)
- 2. Not used
- 3. Blue (-)
- 4. Black (Test in)

\*: Test (black wire) = 0V, Emitter Off.

### Sensing Characteristics (Typical)

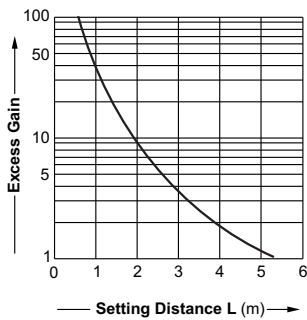

Thru-beam Sensor

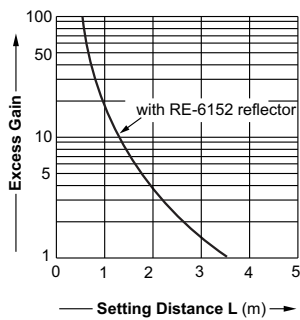

Retro-reflective Sensor (Sn=2m)

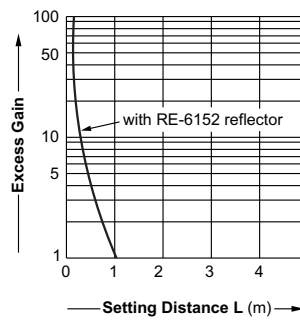

Retro-reflective Sensor (Sn=1m, with polarizing filter)

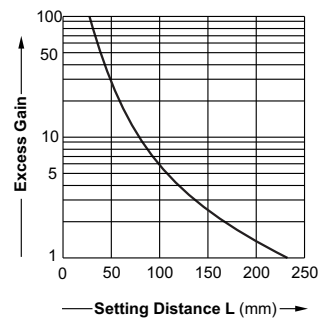

Diffuse Sensor

## Dimensions (Unit: mm)

### Plastic Housing Type Sensor

#### Standard Shape (X shape)

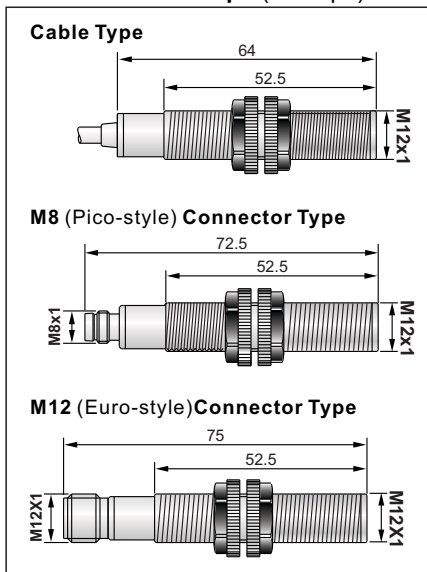

#### Y-Shape

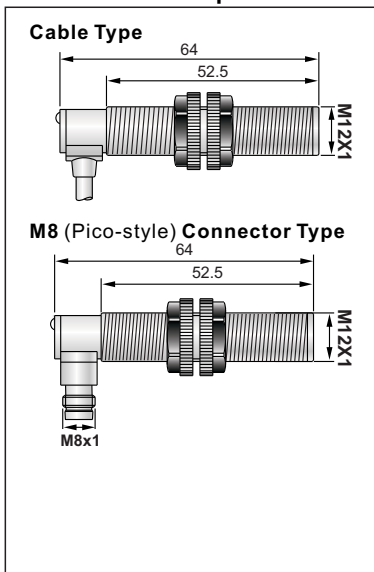

#### Z-Shape

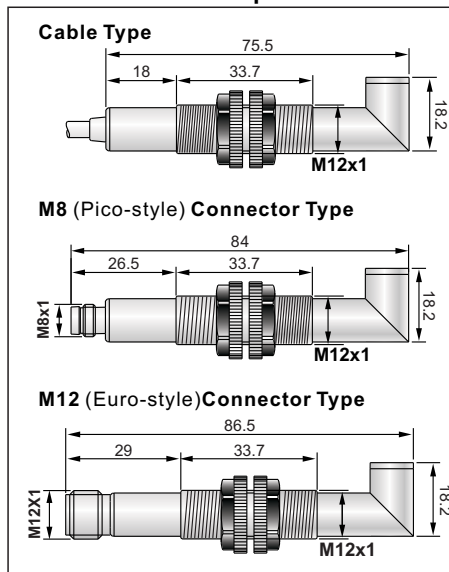

### Brass Housing Type Sensor

#### Standard Shape (X shape)

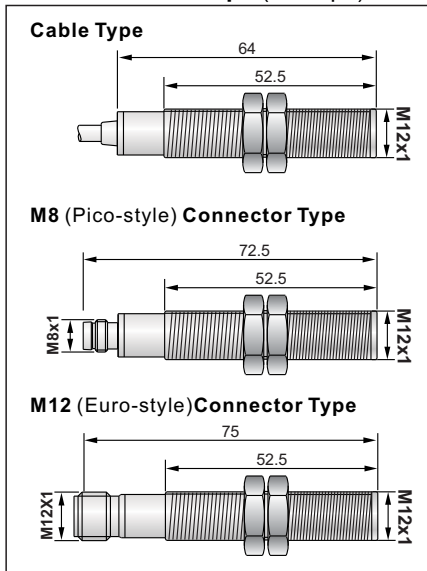

#### Y-Shape

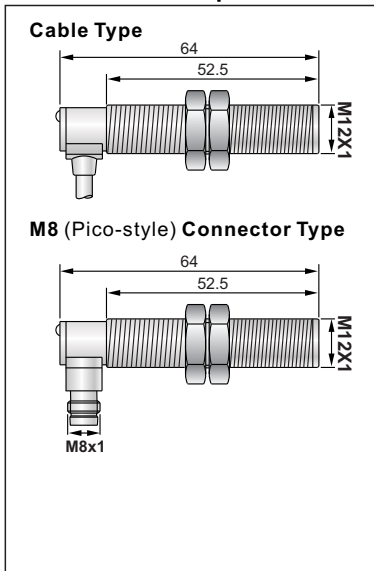

#### Z-Shape

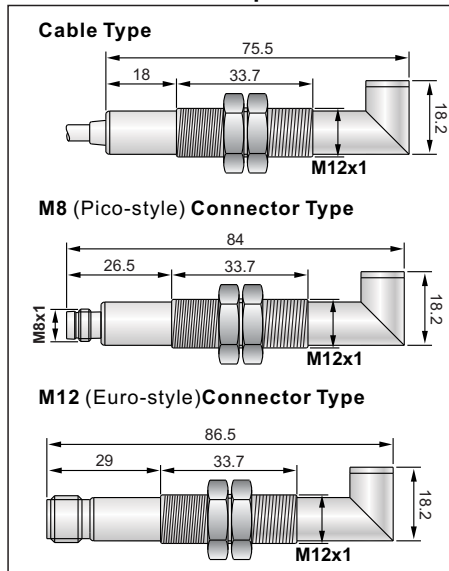

### Pigtail\* Type

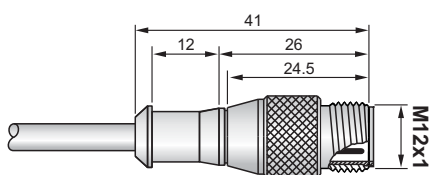

\*: Please see **Pigtail Series** or our **Cables & Connectors** catalogue for more information.

### MB-3026 (Mounting Bracket\*-optional)

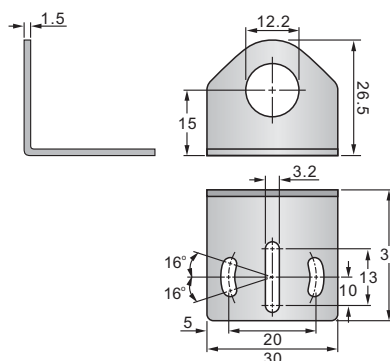

\*: Please see **Accessories** (Universal Mounting Brackets Series).